

GM5□□95200A series

3528 Size, 1.9mm Thickness, Leadless Chip LED

■ Outline Dimensions

(Unit : mm)

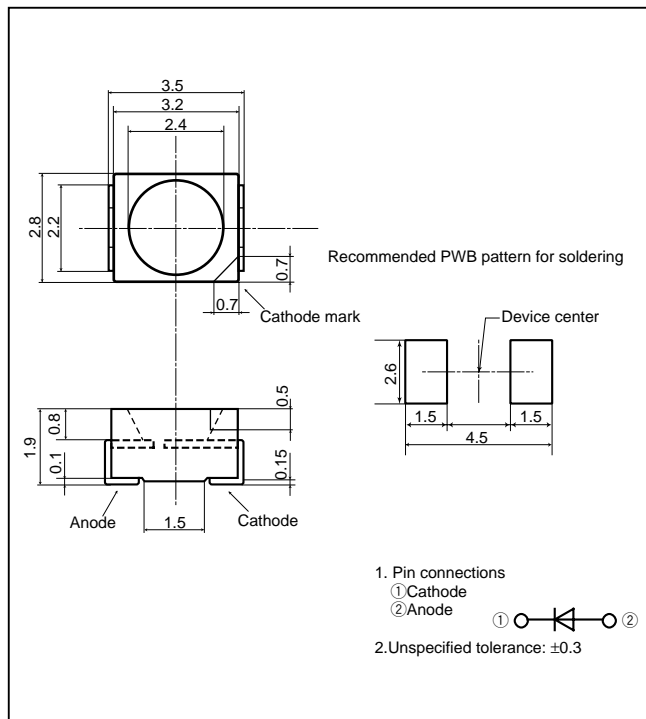

GM5UR95200A: polarity inversion type

■ Directive Characteristics

(T_a=25°C)

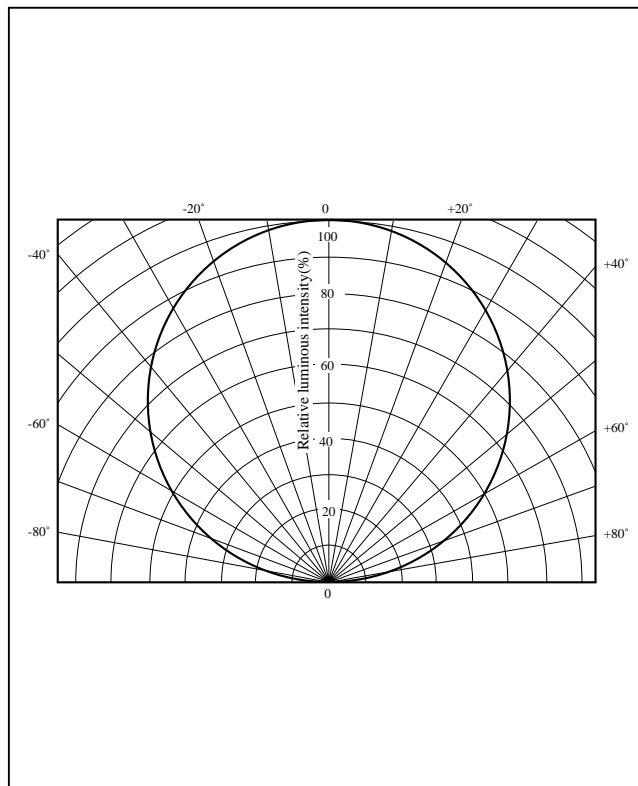

■ Absolute Maximum Ratings

(T_a=25°C)

Model No.	Emitting color	Material	Power dissipation P (mW)	Forward current I _F (mA)	Peak forward current I _{FM} *1 (mA)	Derating factor (mA/°C)		Reverse voltage V _R (V)	Operating temperature T _{opr} (°C)	Storage temperature T _{stg} (°C)	Soldering temperature T _{sol} *2 (°C)
						DC	Pulse				
GM5UR95200A	Red(Super-luminosity)	GaAlAs on GaAlAs	75	30	50	0.40	0.67	4	-55 to +110	-55 to +110	295
GM5HD95200A	Red	GaAsP on GaP	85	30	50	0.40	0.67	5	-55 to +110	-55 to +110	295
GM5EG95200A	Yellow-green	GaP	84	30	50	0.40	0.67	5	-55 to +110	-55 to +110	295

*1 Duty ratio=1/10, Pulse width=0.1ms

*2 For 3s or less at the temperature of hand soldering. Temperature of reflow soldering is shown on page 2.

■ Electro-optical Characteristics

(I_F=20mA, T_a=25°C)

Lens type	Model No.	Forward voltage V _F (V)		Peak emission wavelength λ _p (nm)	Luminous intensity I _v (mcd)	Spectrum radiation bandwidth Δλ(nm)	Reverse current		Terminal capacitance		Page for characteristics diagrams
		TYP	MAX				I _R (μA) MAX	V _R (V)	C _t (pF) TYP	(MHz)	
Colorless transparency	GM5UR95200A	1.85	2.5	660	80	20	10	4	25	1	46
	GM5HD95200A	2.0	2.8	635	13.8	35	10	4	20	1	47
	GM5EG95200A	2.1	2.8	565	18.1	30	10	4	35	1	49

Characteristics Diagrams

UR,U series

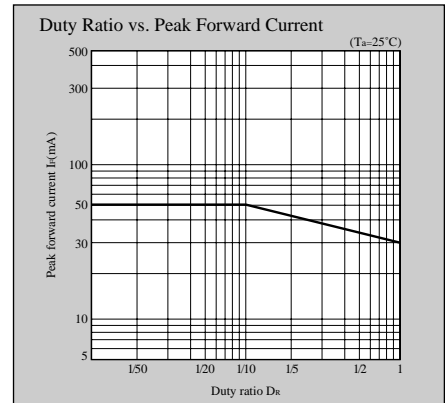
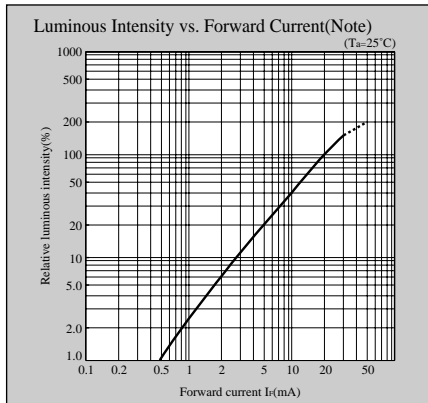
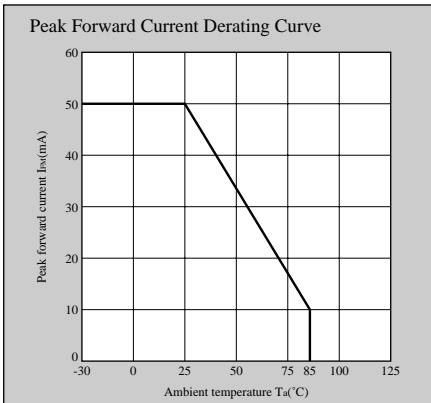
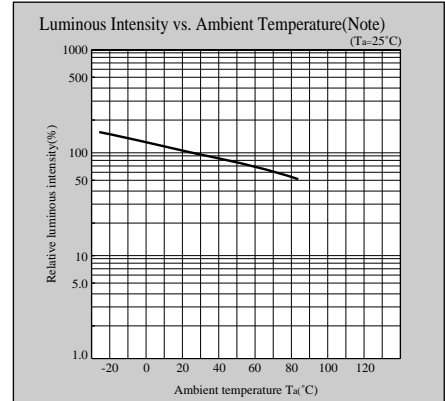
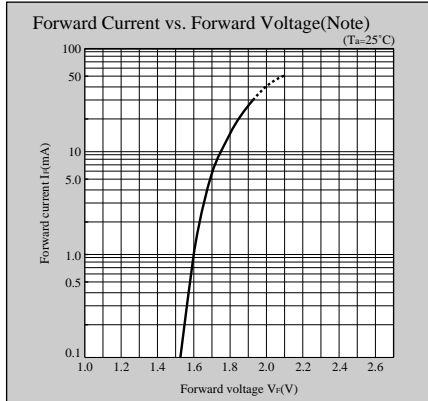
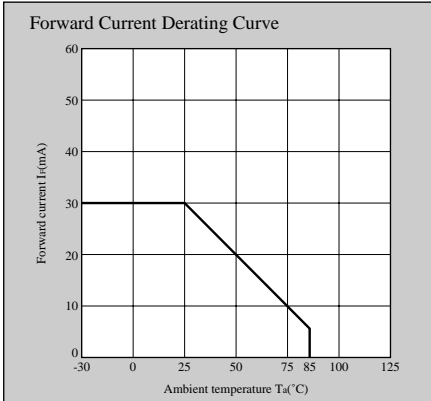

TR,T series

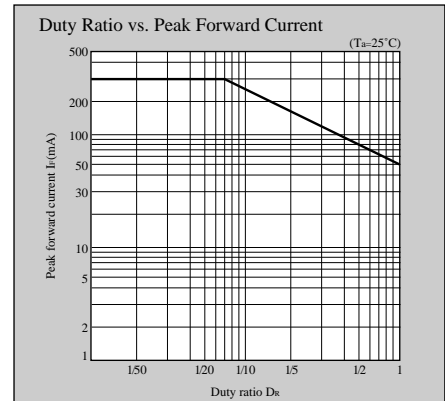
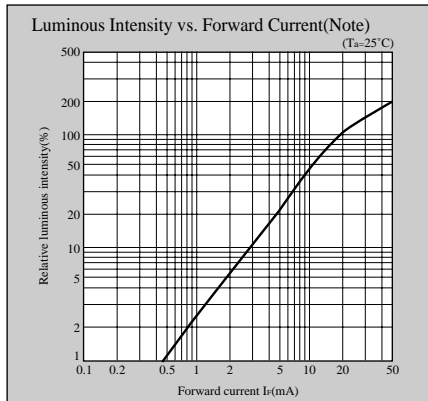
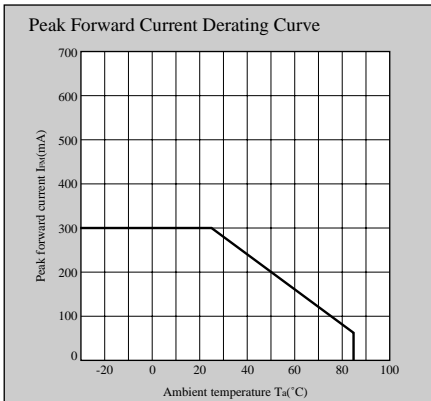
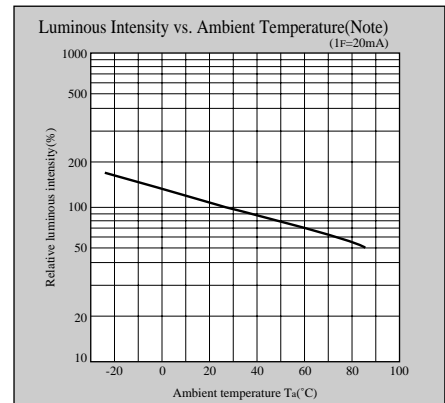
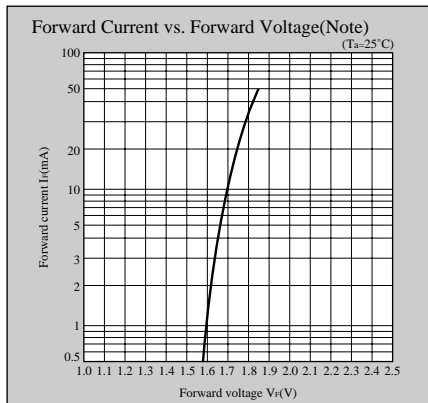
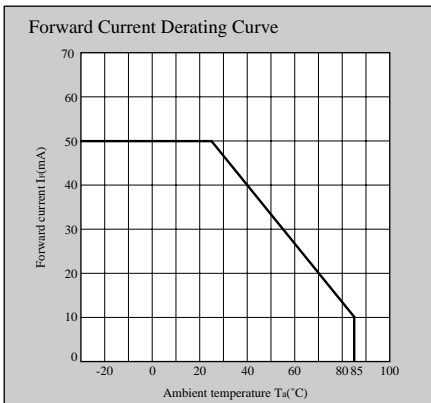

Note) Characteristics shown in diagrams are typical values. (not assurance value)

Characteristics Diagrams

PR,P series

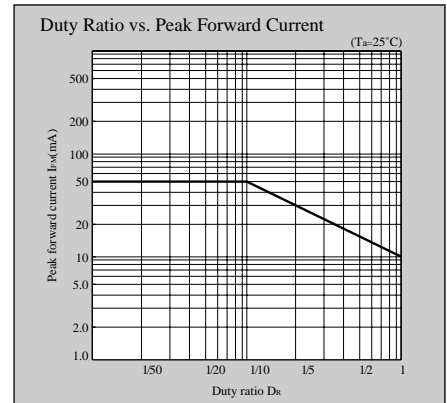
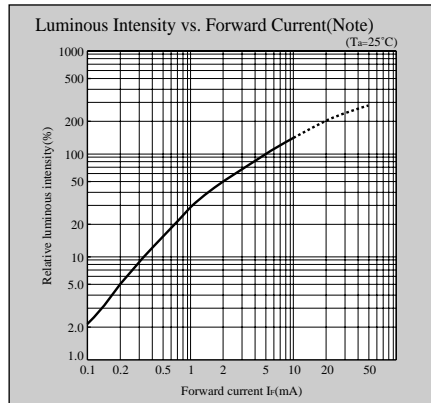
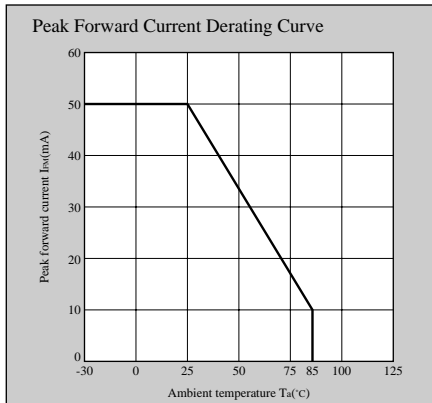
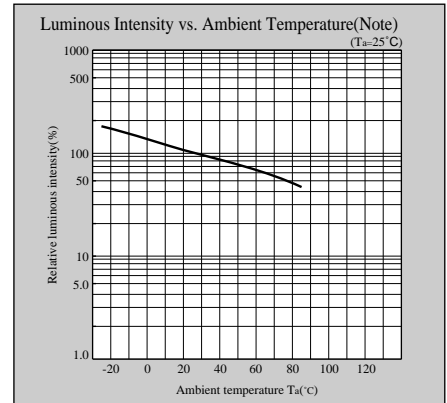
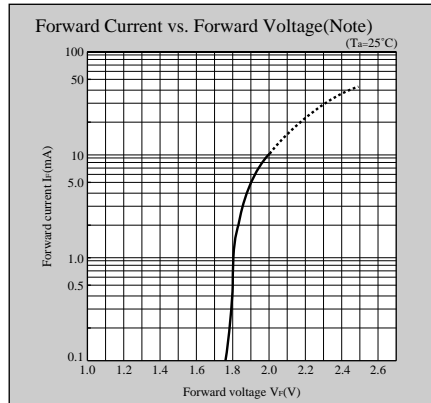
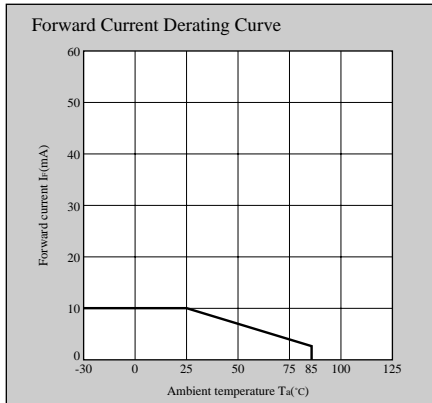

HD,D series

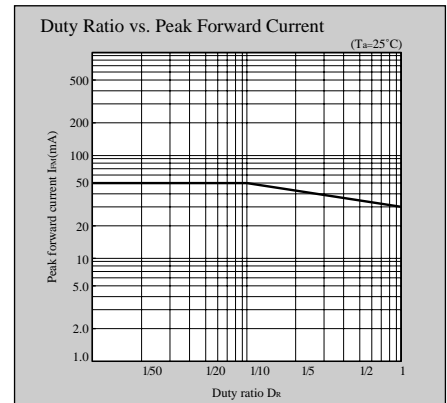
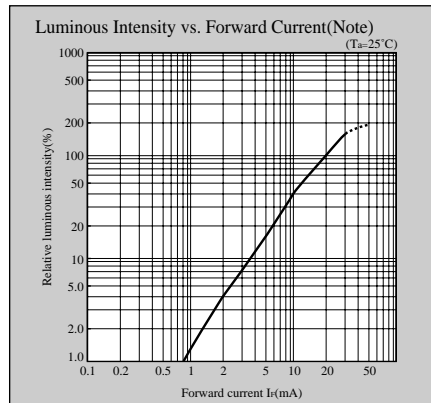
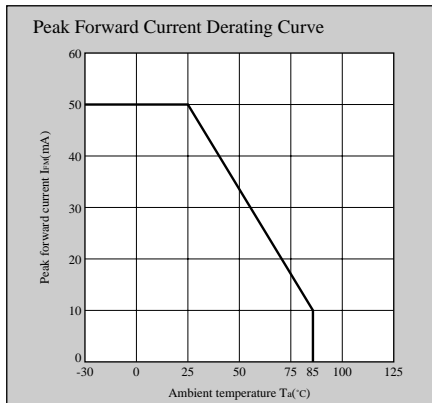
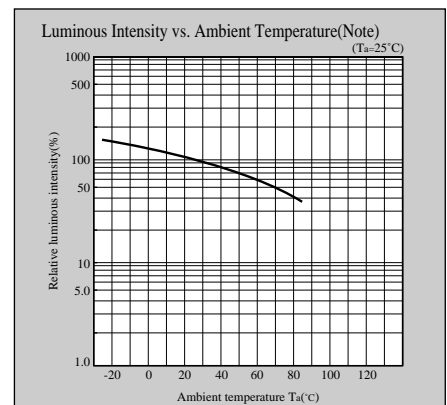
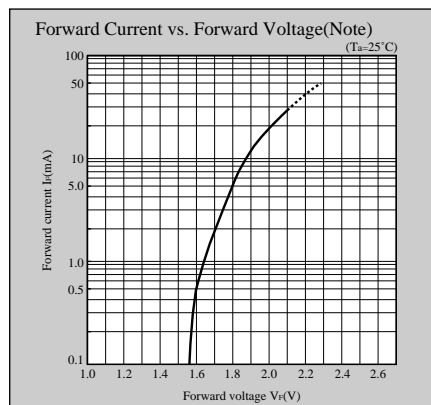
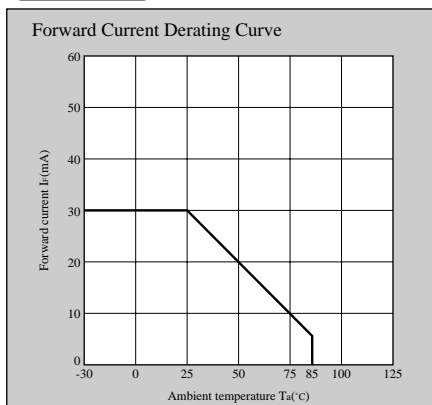

Note) Characteristics shown in diagrams are typical values. (not assurance value)

Notice In the absence of confirmation by device specification sheets, SHARP takes no responsibility for any defects that may occur in equipment using any SHARP devices shown in catalogs, data books, etc. Contact SHARP in order to obtain the latest device specification sheets before using any SHARP device.

Internet Internet address for Electronic Components Group <http://sharp-world.com/ecg/>

Characteristics Diagrams

EG,E series

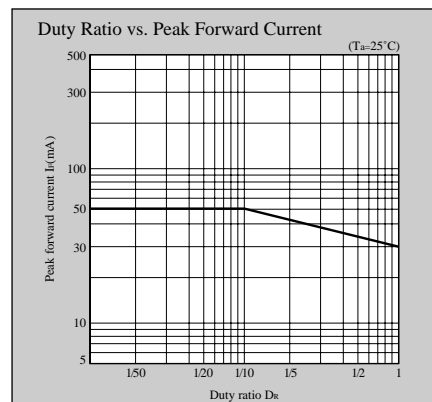
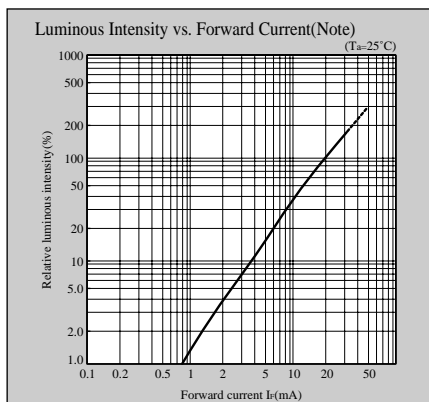
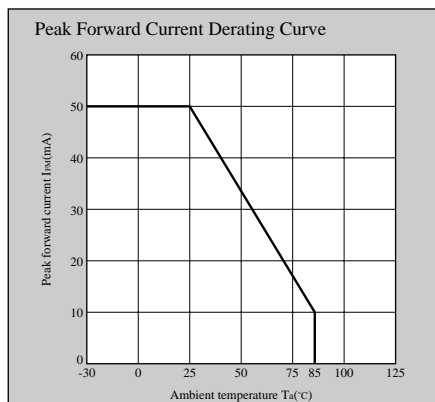
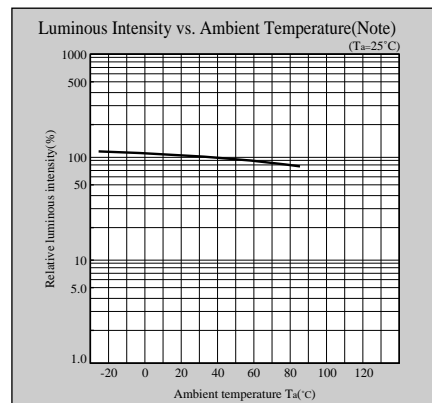
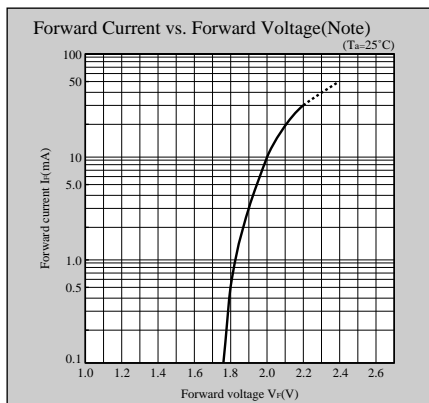
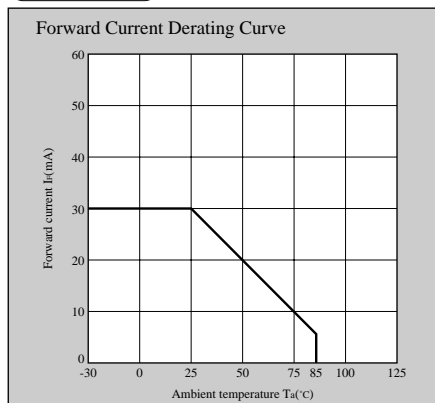

KG,K series

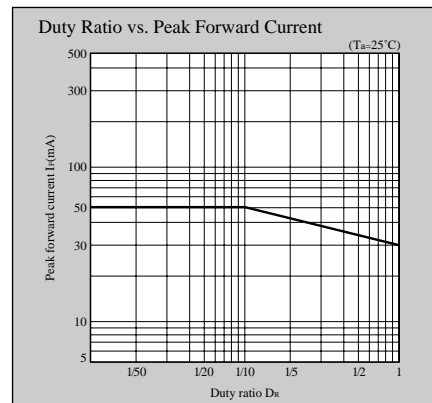
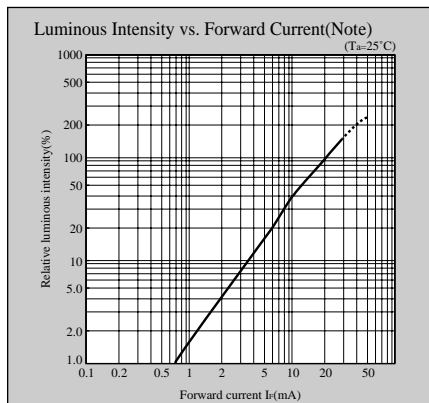
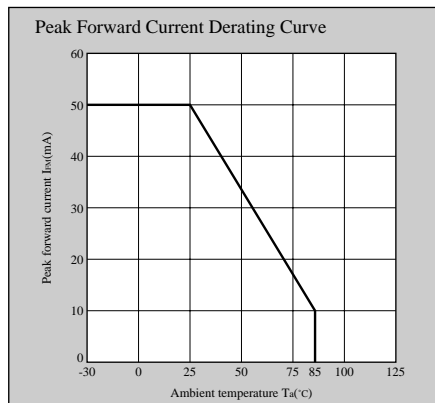
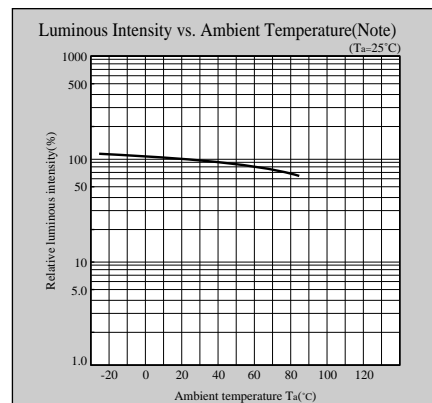
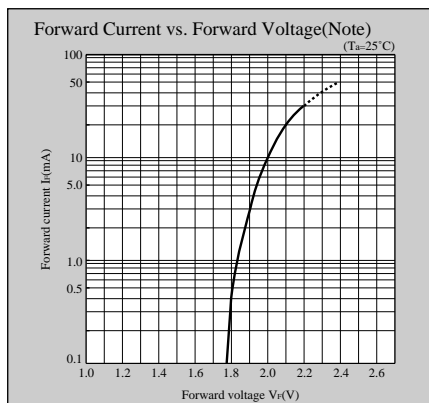
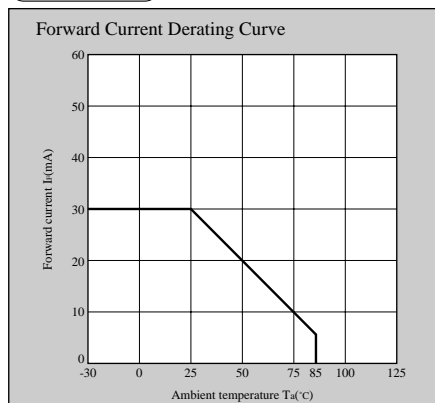

Note) Characteristics shown in diagrams are typical values. (not assurance value)

Notice In the absence of confirmation by device specification sheets, SHARP takes no responsibility for any defects that may occur in equipment using any SHARP devices shown in catalogs, data books, etc. Contact SHARP in order to obtain the latest device specification sheets before using any SHARP device.

Internet Internet address for Electronic Components Group <http://sharp-world.com/ecg/>

NOTICE

The circuit application examples in this publication are provided to explain representative applications of SHARP devices and are not intended to guarantee any circuit design or license any intellectual property rights. SHARP takes no responsibility for any problems related to any intellectual property right of a third party resulting from the use of SHARP's devices.

Contact SHARP in order to obtain the latest device specification sheets before using any SHARP device. SHARP reserves the right to make changes in the specifications, characteristics, data, materials, structure, and other contents described herein at any time without notice in order to improve design or reliability. Manufacturing locations are also subject to change without notice.

Observe the following points when using any devices in this publication. SHARP takes no responsibility for damage caused by improper use of the devices which does not meet the conditions and absolute maximum ratings to be used specified in the relevant specification sheet nor meet the following conditions:

(i) The devices in this publication are designed for use in general electronic equipment designs such as:

- Personal computers
- Office automation equipment
- Telecommunication equipment [terminal]
- Test and measurement equipment
- Industrial control
- Audio visual equipment
- Consumer electronics

(ii) Measures such as fail-safe function and redundant design should be taken to ensure reliability and safety when SHARP devices are used for or in connection with equipment that requires higher reliability such as:

- Transportation control and safety equipment (i.e., aircraft, trains, automobiles, etc.)
- Traffic signals
- Gas leakage sensor breakers
- Alarm equipment
- Various safety devices, etc.

(iii) SHARP devices shall not be used for or in connection with equipment that requires an extremely high level of reliability and safety such as:

- Space applications
- Telecommunication equipment [trunk lines]
- Nuclear power control equipment
- Medical and other life support equipment (e.g., scuba).

Contact a SHARP representative in advance when intending to use SHARP devices for any "specific" applications other than those recommended by SHARP or when it is unclear which category mentioned above controls the intended use.

If the SHARP devices listed in this publication fall within the scope of strategic products described in the Foreign Exchange and Foreign Trade Control Law of Japan, it is necessary to obtain approval to export such SHARP devices.

This publication is the proprietary product of SHARP and is copyrighted, with all rights reserved. Under the copyright laws, no part of this publication may be reproduced or transmitted in any form or by any means, electronic or mechanical, for any purpose, in whole or in part, without the express written permission of SHARP. Express written permission is also required before any use of this publication may be made by a third party.

Contact and consult with a SHARP representative if there are any questions about the contents of this publication.